

THIS DRAWING AND INFORMATION CONTAINED HEREON ARE THE PROPERTY OF CHOMERICS, AND MUST NOT BE COPIED OR DISCLOSED EITHER WHOLLY OR IN PART WITHOUT WRITTEN PERMISSION OF CHOMERICS.

ECN NO.	REV	REVISION	BY	ENG.	DATE
H05069	A	UPDATE	WR	WR	10/7/05

This design/proposal is provided subject to Chomerics Offer of Sales Terms and Conditions, which are available on line at www.chomerics.com/salesterms/ or can be provided by your Chomerics representative."

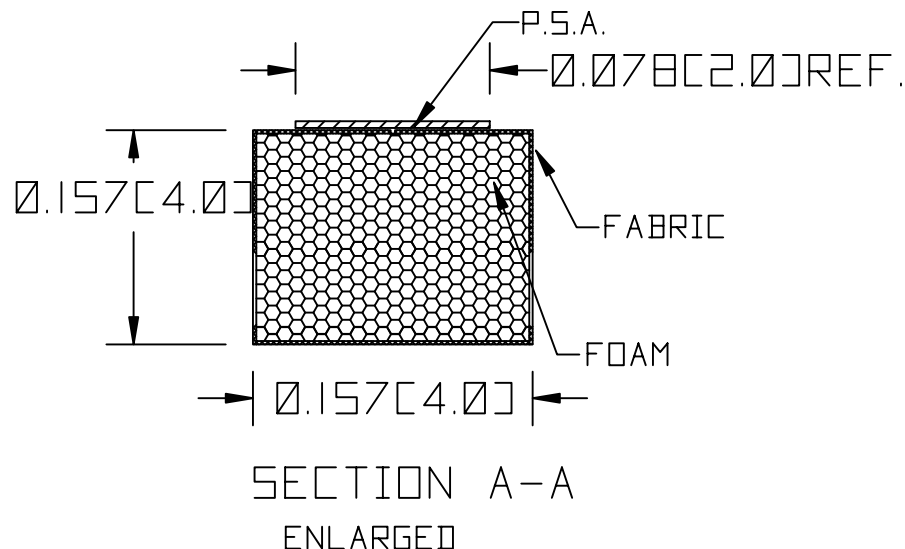
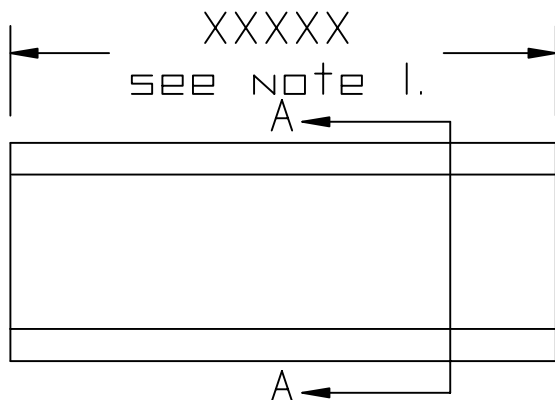

NOTE:

1. UNLESS SPECIFIED CHOMERICS STANDARD CUT TO LENGTH TOLERANCES APPLY.
2. UNLESS SPECIFIED PRESSURE SENSITIVE ADHESIVE (P.S.A.) TO BE 3M 950 OR EQUIVALENT.
3. SEE CHOMERICS 553500 TECHNICAL DATA SHEET FOR PRODUCT SPECIFICATIONS.

UNLESS OTHERWISE SPECIFIED, ALL DIMENSIONS ARE IN INCHES [MILLIMETERS].

DO NOT SCALE PRINT
TOLERANCES UNLESS SPECIFIED FRACTIONAL 2 DIGIT DECIMAL ± .05 3 DIGIT DECIMAL ± .020 ANGULAR .5°
SCALE NONE
SUPERSEDES
DRAWN BY W.A.R. 2/6/03
APPROVAL
APPROVAL

CHOMERICS
A Division of Parker Hannifin
COMPUTER GENERATED DRAWING DO NOT MAKE MANUAL CHANGES

TITLE
PART DRAWING

DRAWING NO.
77-XX-3107-XXXXX

CUSTOMER NAME:
TOOLING: